

Typical Single Frame with Decking
N.T.S.

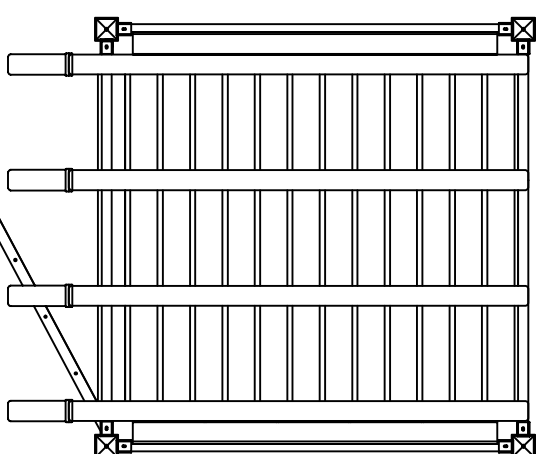

Single Model Top View
N.T.S.

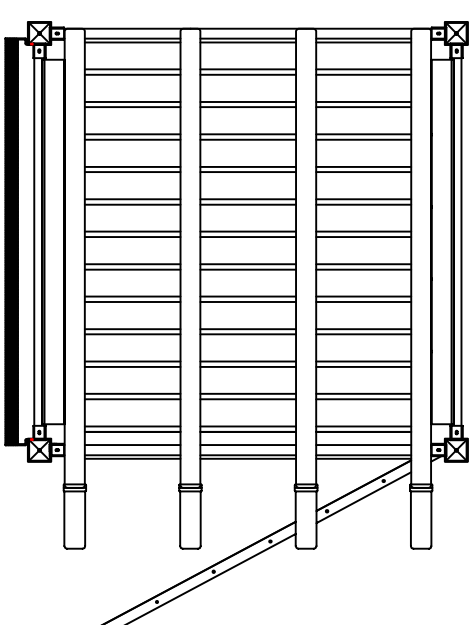

Single Model Top Left Side View
N.T.S.

View of Layout

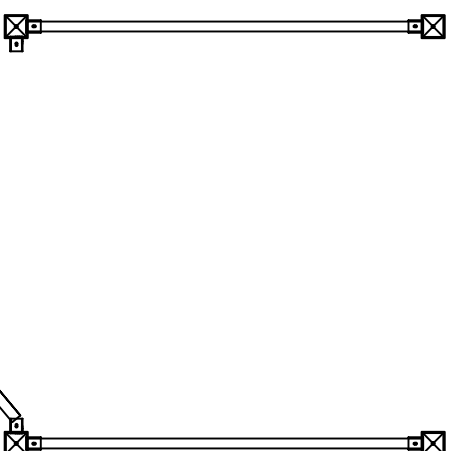

Model STP-1 (46")

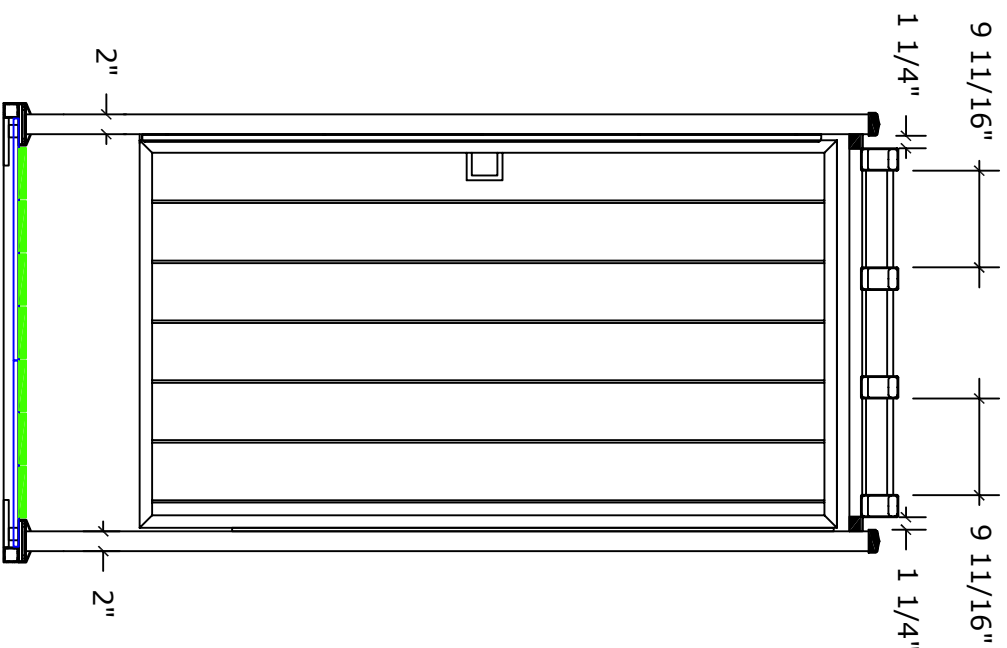

Single Model Elevation
N.T.S.

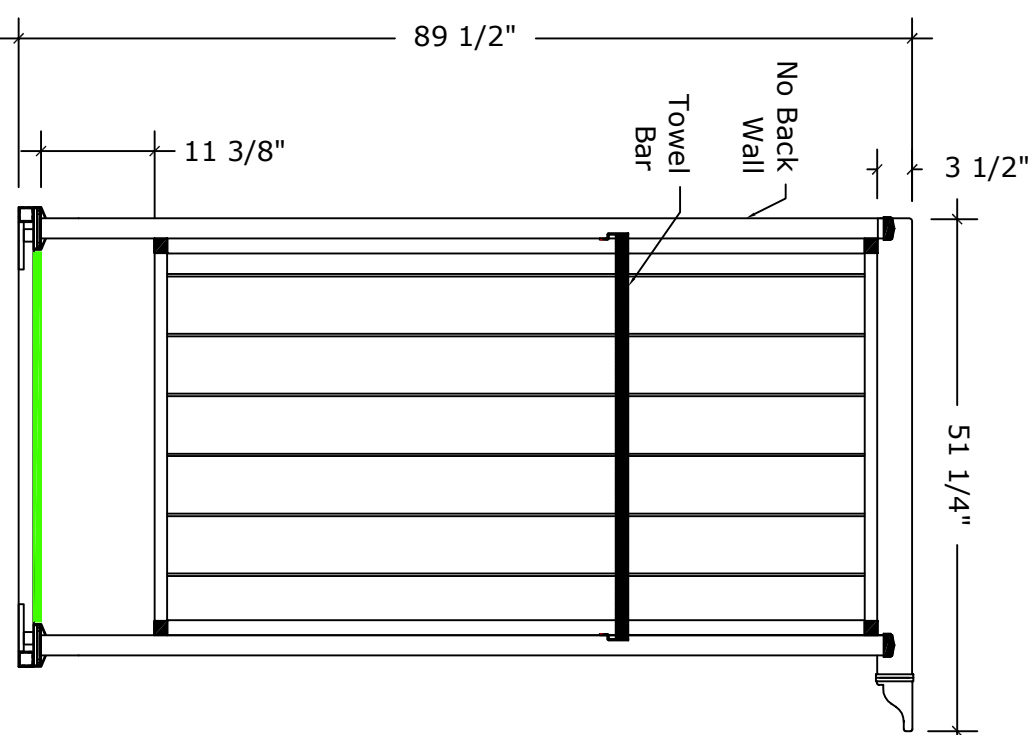

Single Model Side Elevation
N.T.S.